

# СОСТАВ: 52 ДЕТАЛИ

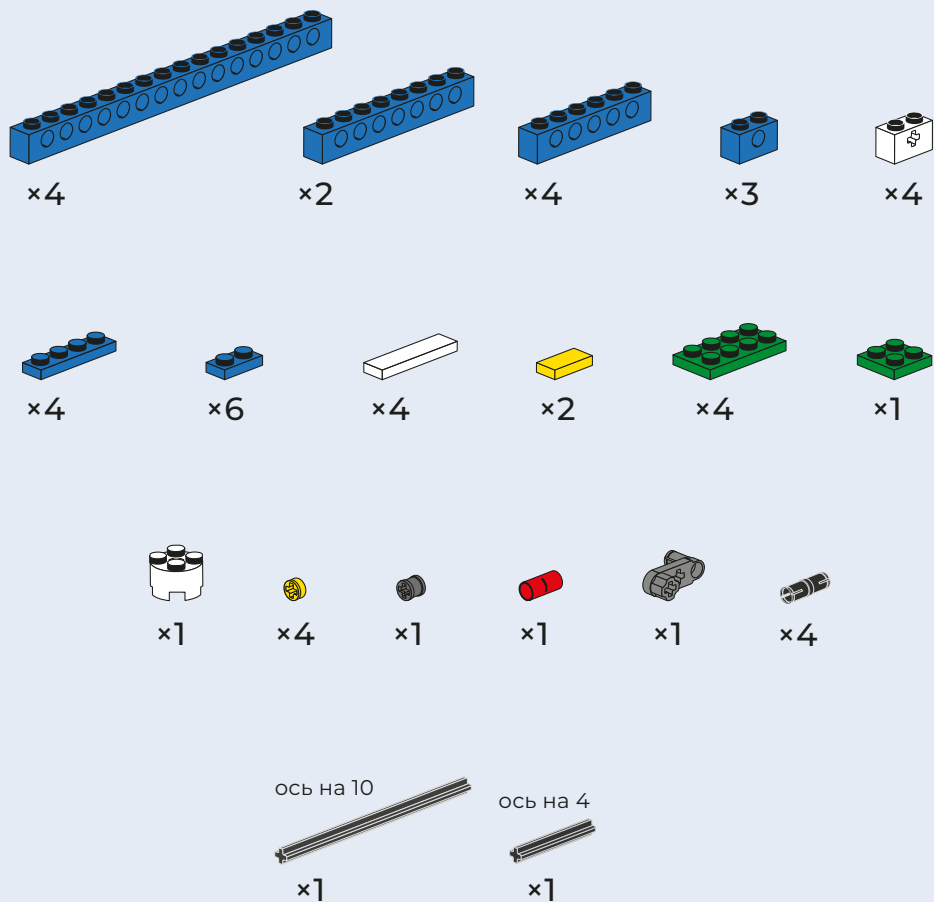

# ОБЕЗЬЯНКА

Набор простых механизмов

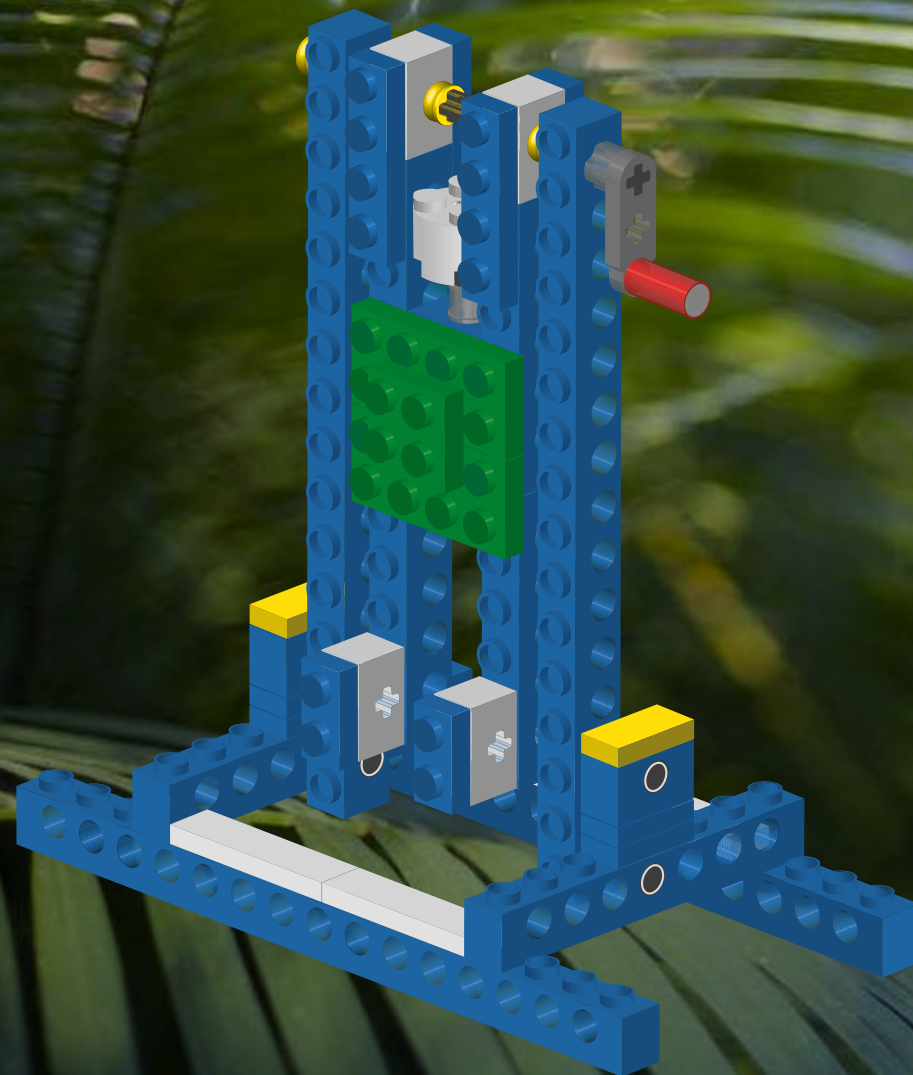

# 1 ЧАСТЬ: ТУРНИК ДЛЯ ОБЕЗЬЯНКИ

1

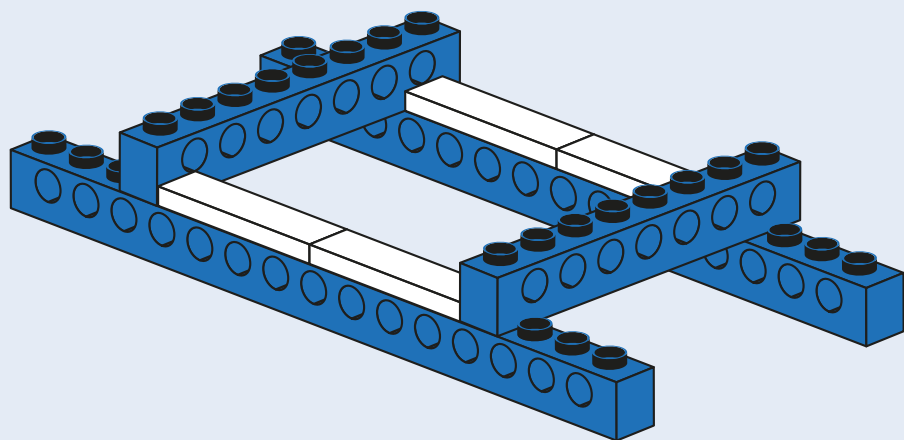
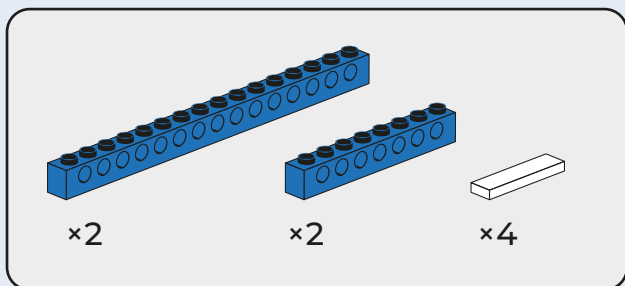

2

2

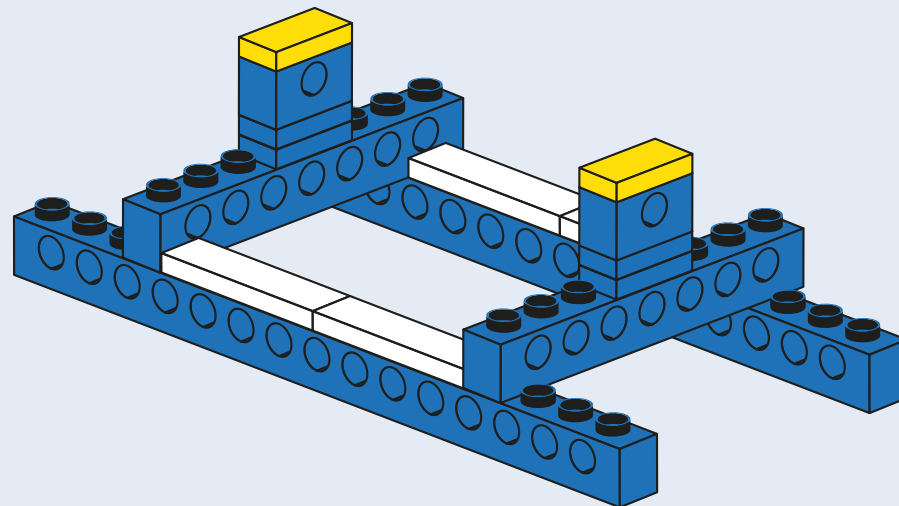
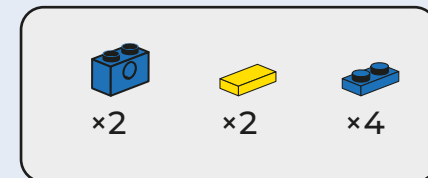

3

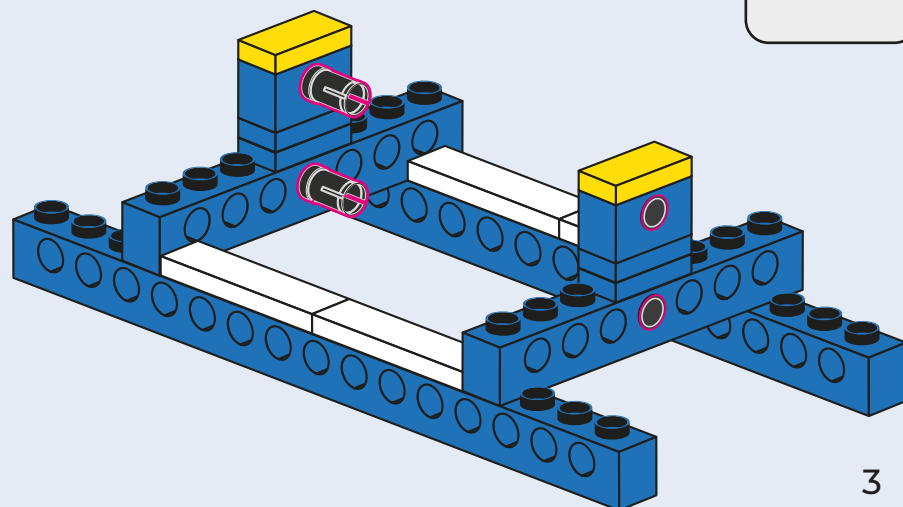

3

4

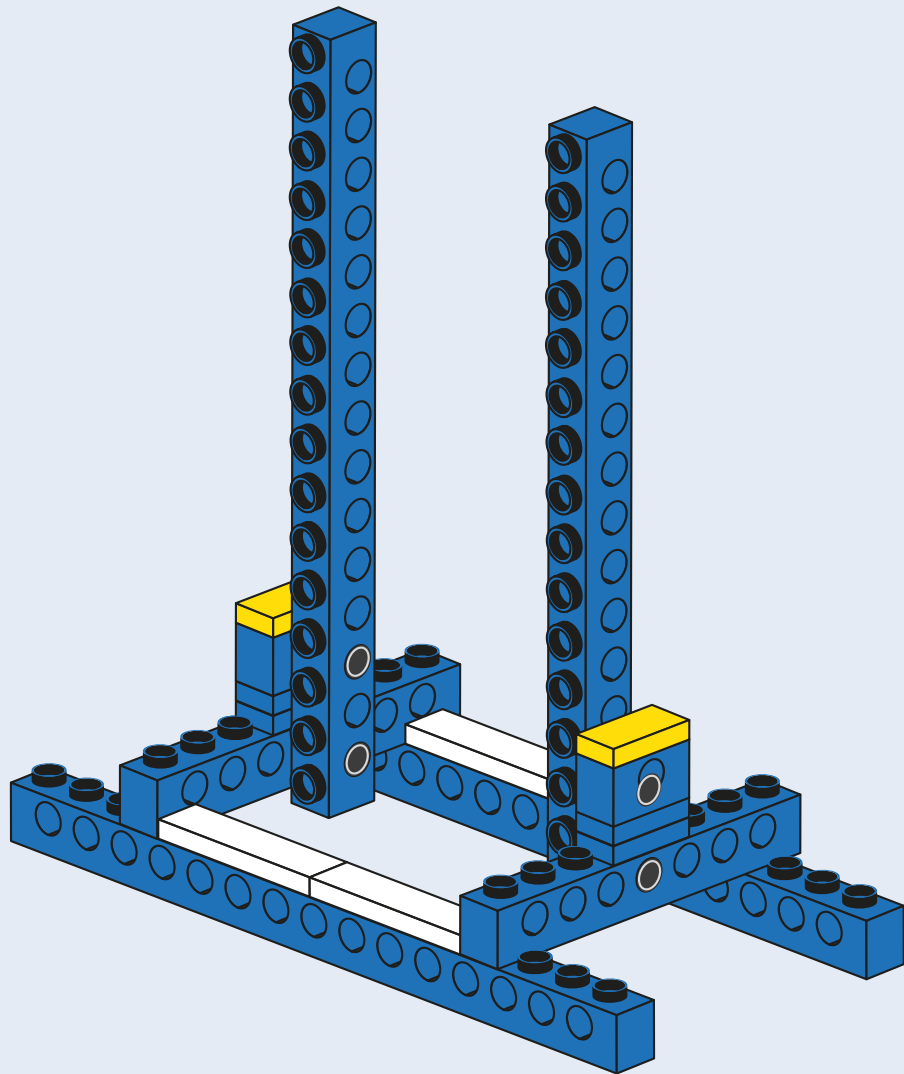
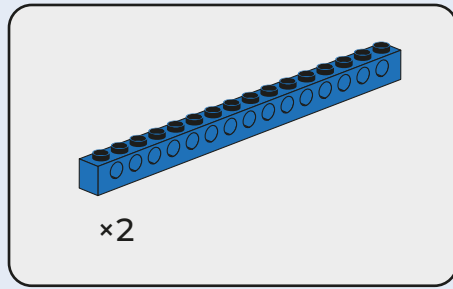

4

## 2 ЧАСТЬ: ОБЕЗЬЯНКА

5

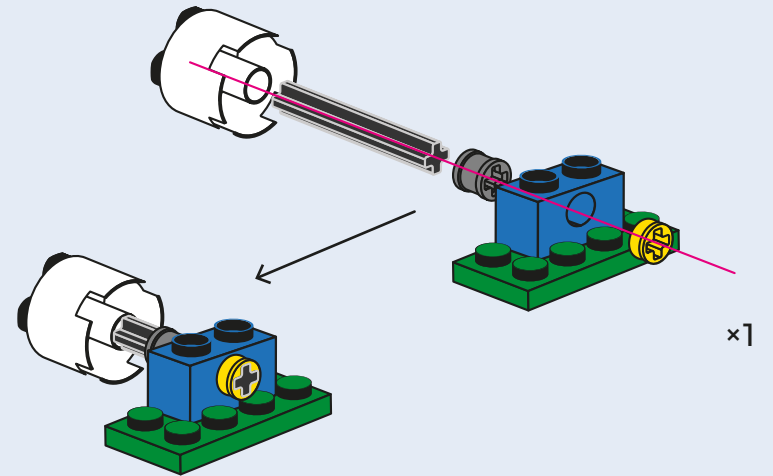
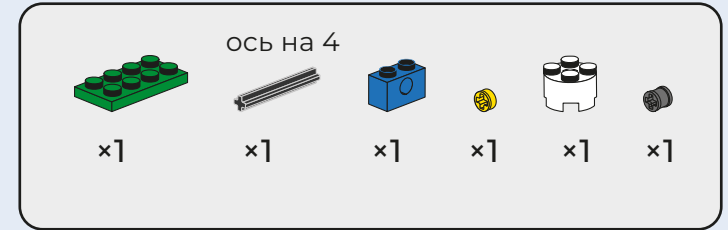

6

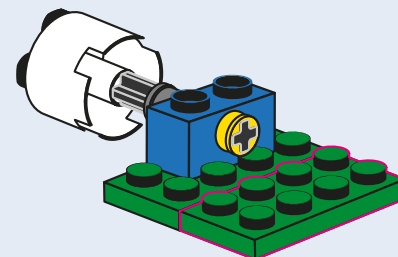
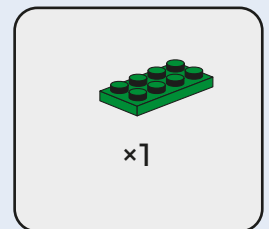

5

7

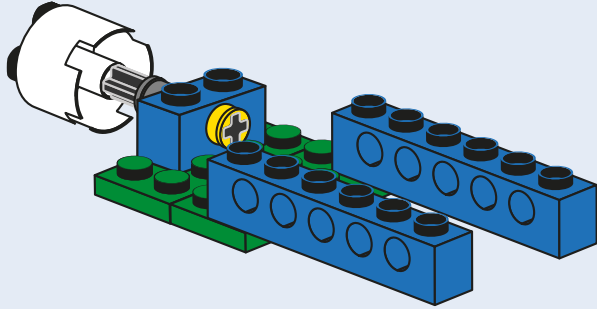
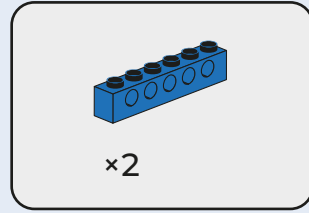

9

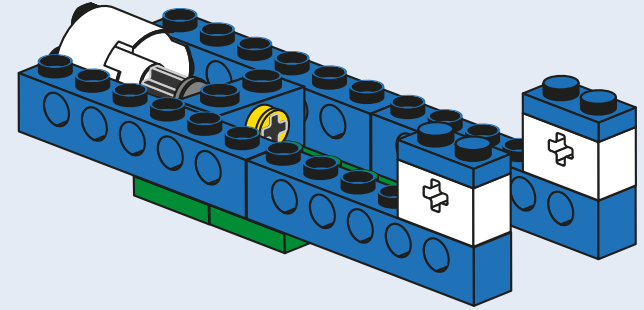
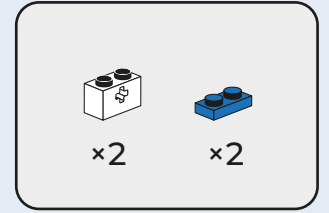

8

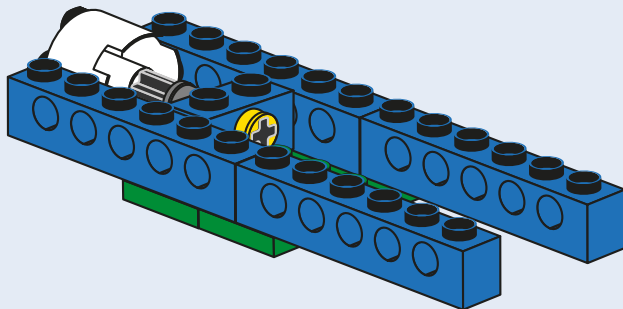
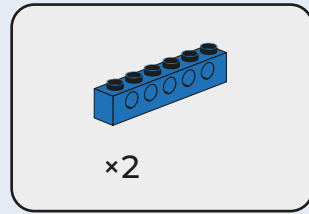

10

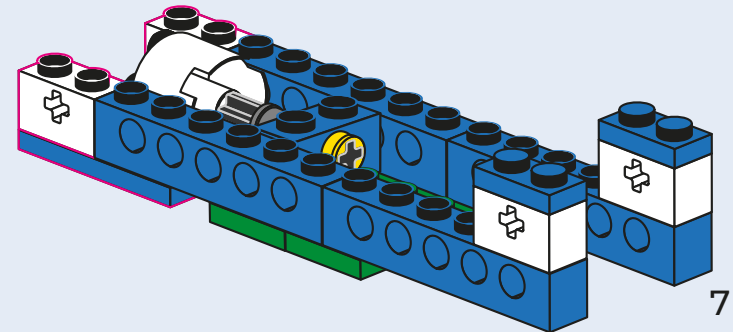
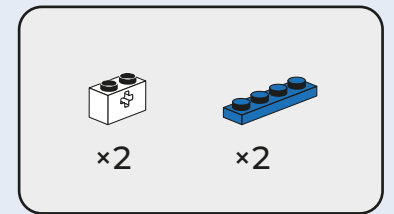

# 11

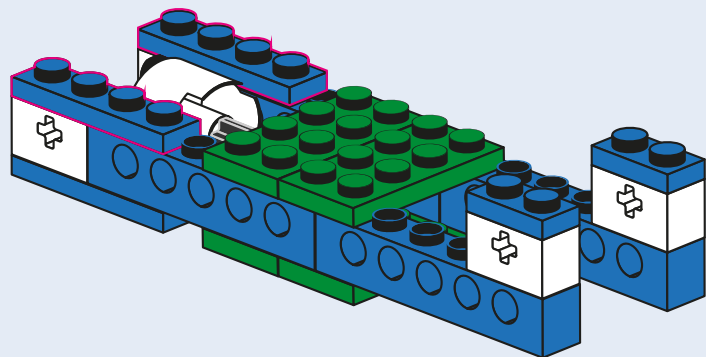
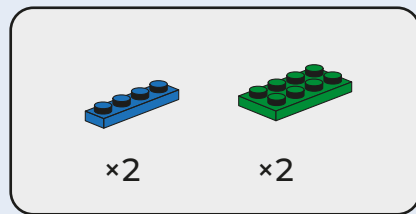

# 12

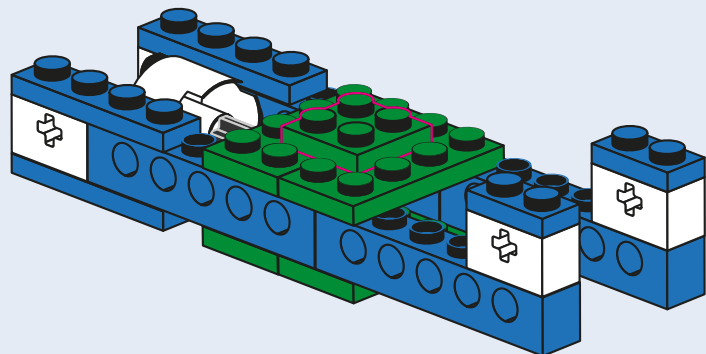
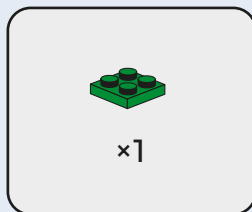

# 13

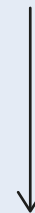

Поверните  
конструкцию,  
как показано  
ниже

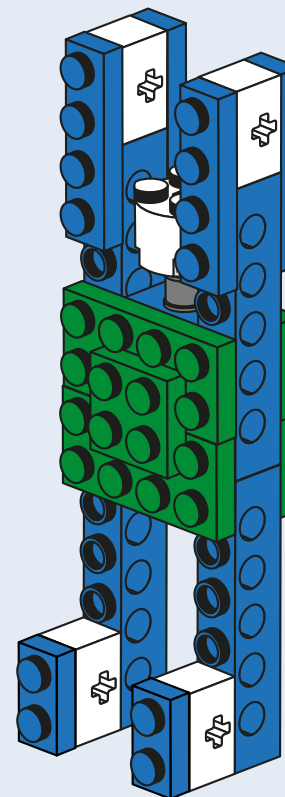

# 14

Соедините части 1 и 2

ось на 10



x1



x3

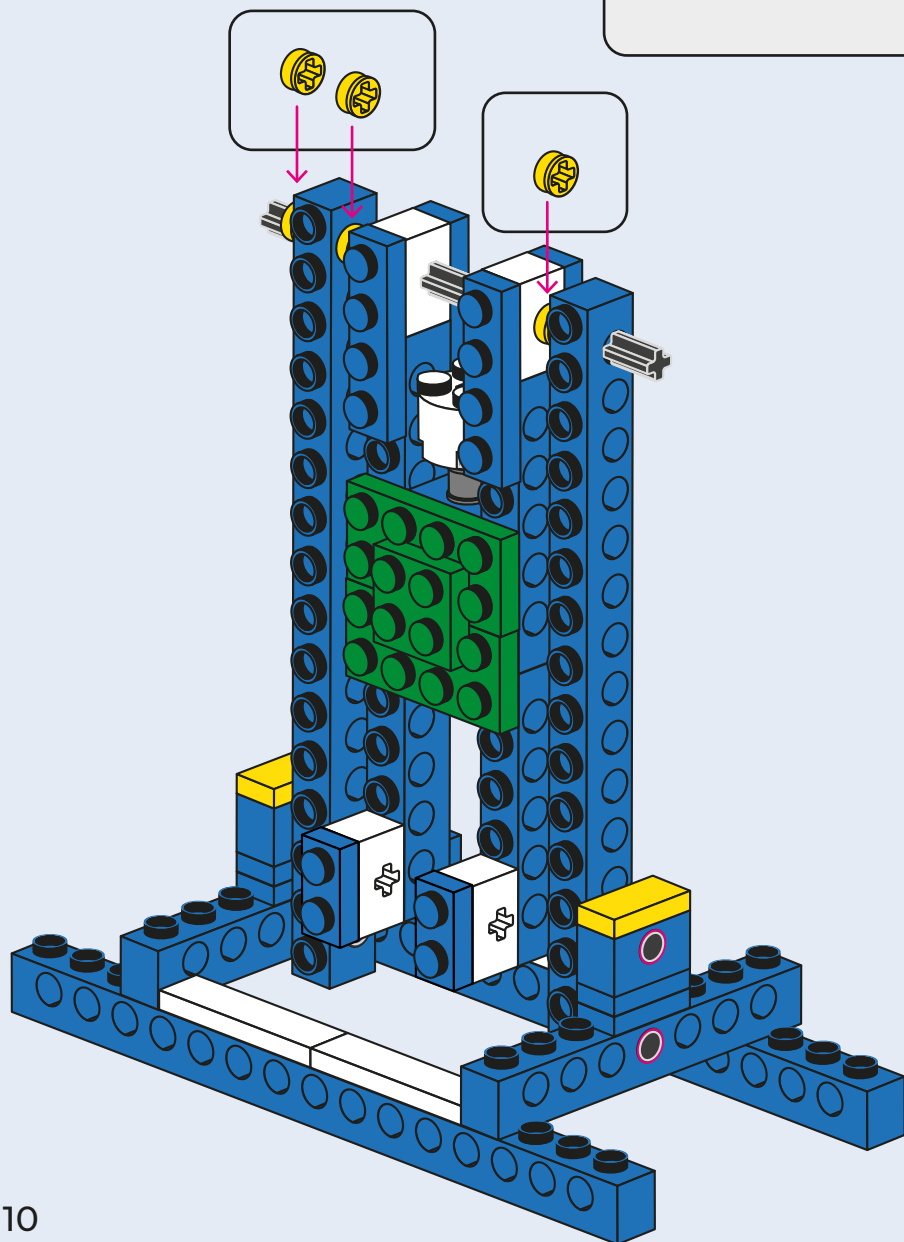

# 15



x1



x1

